

NPN

New Product News



CADAPTER

2-way high pressure T-holder type C-ADAPTER Launch



KEY POINT

TaeguTec has launched a 2-way high-pressure T-holder type C-ADAPTER.

To meet the diverse needs of customers, TaeguTec has expanded the C-ADAPTER family by adding a 2-way, high-pressure T-holder type C-ADAPTER that uses RHINO-TURN, RHINO-X-TURN, and POS-S-TURN (XNMV) inserts.

The 2-way high-pressure coolant supply (COOL-BURST), a key feature of the new product, raises the productivity of the high-precision quick change tool system C-ADAPTER product line.

For further information, please contact the product manager.

Features

- 2-way high-pressure coolant improves tool life and chip control
- Pinpointed coolant supply to the cutting edge means higher cutting speed capability
- Improved productivity due to the quick change tool capability
- The same T-Holder's simple clamping operation and strong clamping force

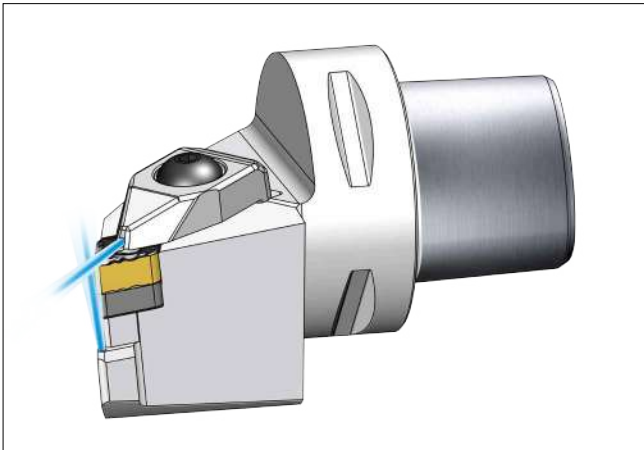

TCLNR/L-TB



High-pressure T-holders with C-ADAPTER

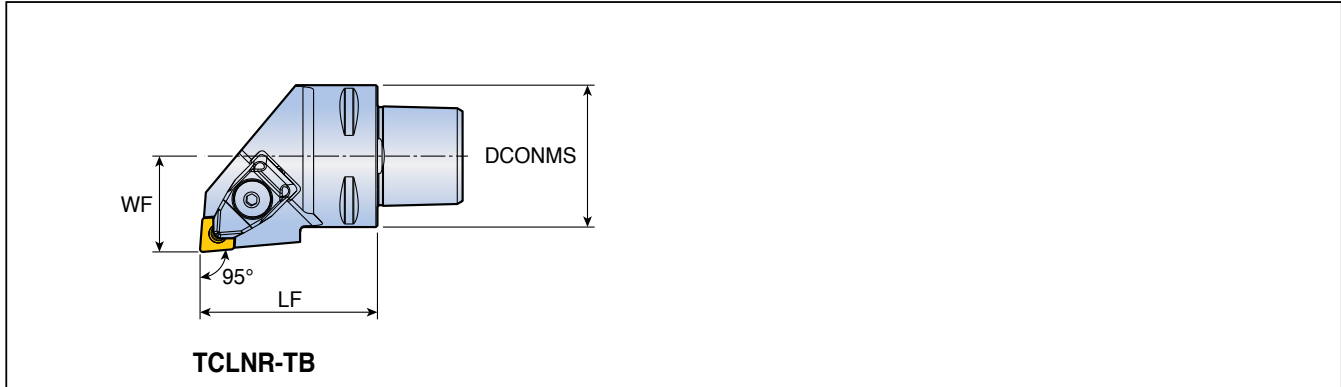

Approach angle	Designation	Dimension (mm)			Insert
		DCONMS	WF	LF	
95°	C4-TCLNR/L 27050-0904-TB	40	27	50	CN... 0904... RHINOTURN
	C5-TCLNR/L 35060-0904-TB	50	35	60	

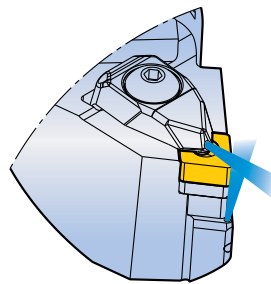
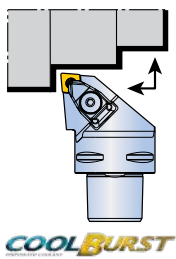

Spare parts

Designation	Clamp	Clamp Screw	Spring	Upper O-ring	Lower O-ring	Shim	Shim Screw	Wrench	
TCLNR/L-TB	DLM 3-NX-TB	BH M4x0.7x16-TB	DSP 3	O-RING ID4.47x1.78	O-RING ID6.07x1.78	LSC 32A	SO 40085I	L-W 3	T 15

TDJNR/L-TB



High-pressure T-holders with C-ADAPTER

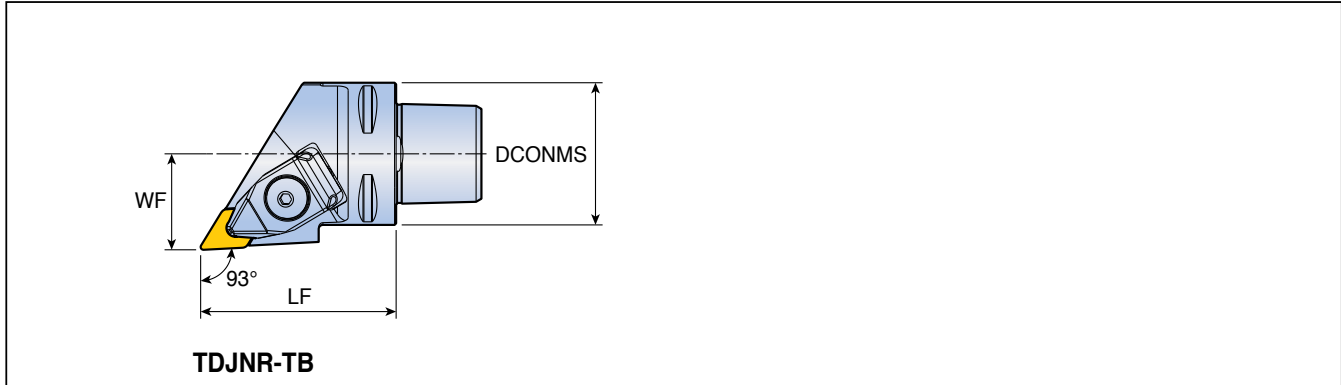

Approach angle	Designation	Dimension (mm)			Insert
		DCONMS	WF	LF	
93°	C4-TDJNR/L 27055-1305-TB	40	27	55	DN... 1305... <i>RHINOTURN</i>
	C5-TDJNR/L 35060-1305-TB	50	35	60	

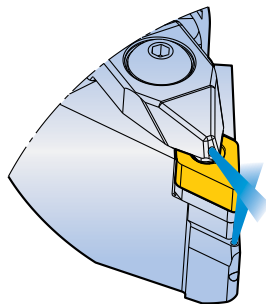
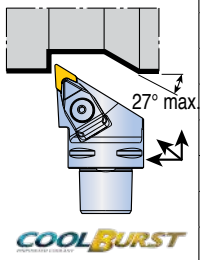

Spare parts

Designation	Clamp	Clamp Screw	Spring	Upper O-ring	Lower O-ring	Shim	Shim Screw	Wrench	
TDJNR/L-TB	DLM 3.5-NX-TB	BH M5x0.8x 21-MO-TB	DSP 4	O-RING ID5.28x 1.78	O-RING ID7.59x 2.62	LSD 3.52	SO 500901-MO	L-W 3	T 20

TVJNR/L-TB



High-pressure T-holders with C-ADAPTER

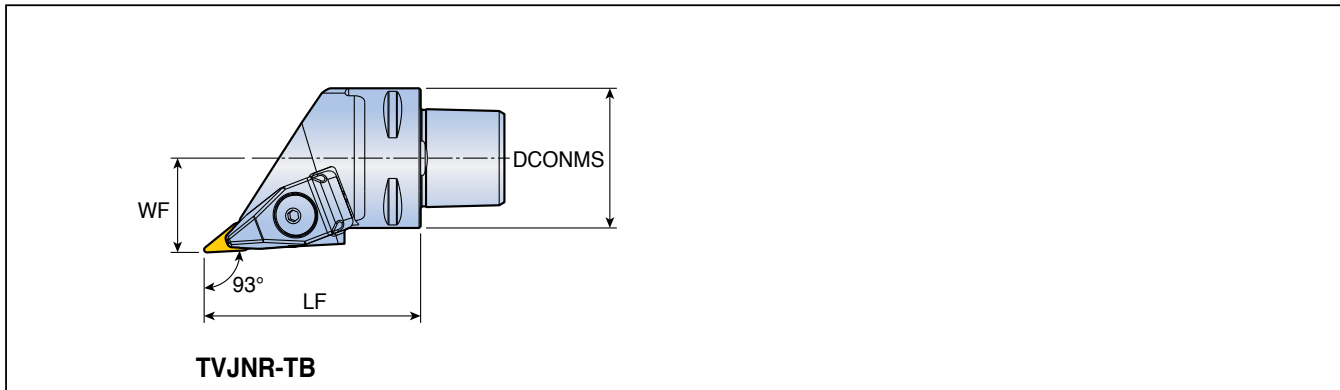

Approach angle	Designation	Dimension (mm)			Insert
		DCONMS	WF	LF	
93°	C4-TVJNR/L 27062-1304-TB	40	27	62	VN...X 1304...
	C5-TVJNR/L 35065-1304-TB	50	35	65	RHINOTURN

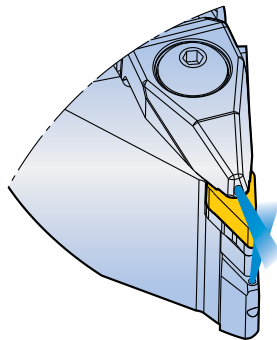
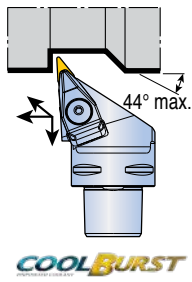

Spare parts

Designation	Clamp	Clamp Screw	Spring	Upper O-ring	Lower O-ring	Shim	Shim Screw	Wrench	
TVJNR/L-TB	DLM 2.5V-NX-TB	BH M5x0.8x 21-MO-TB	DSP 4	O-RING ID5.28x 1.78	O-RING ID7.59x 2.62	MSVI 2.522	SO 40085I	L-W 3	T 15

TWLNR/L-TB



High-pressure T-holders with C-ADAPTER

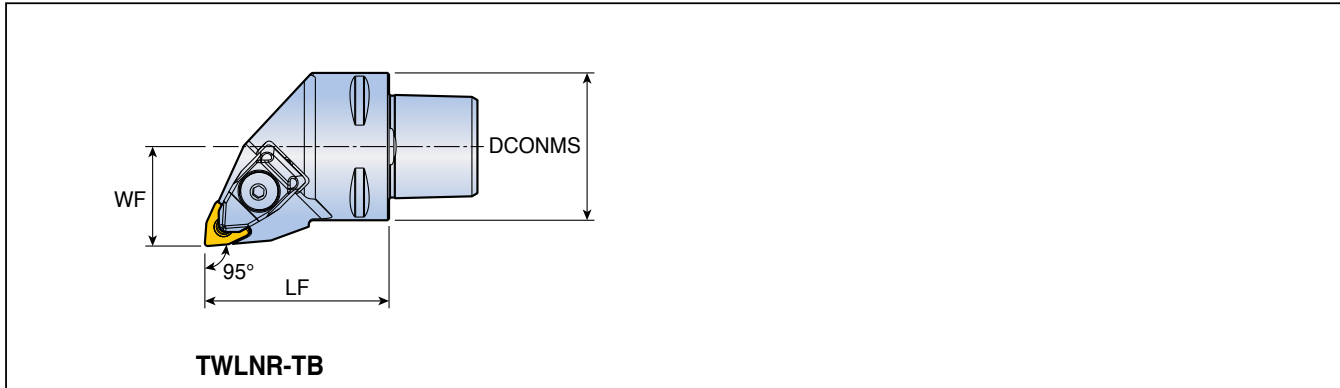

Approach angle	Designation	Dimension (mm)			Insert
		DCONMS	WF	LF	
95°	C4-TWLNR/L 27050-0604-TB	40	27	50	WN...X 0604...
	C5-TWLNR/L 35060-0604-TB	50	35	60	RHINO TURN

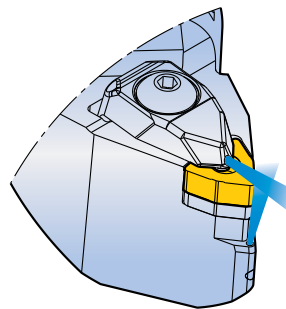

Spare parts

Designation	Clamp	Clamp Screw	Spring	Upper O-ring	Lower O-ring	Shim	Shim Screw	Shim Screw	
TWLNR/L-TB	DLM 3-NX-TB	BH M4x0.7x 16-TB	DSP 3	O-RING ID4.47x 1.78	O-RING ID6.07x 1.78	LSW 32A	SO 40085I	L-W 3	T 15

TXJNR/L-TB



High-pressure T-holders with C-ADAPTER

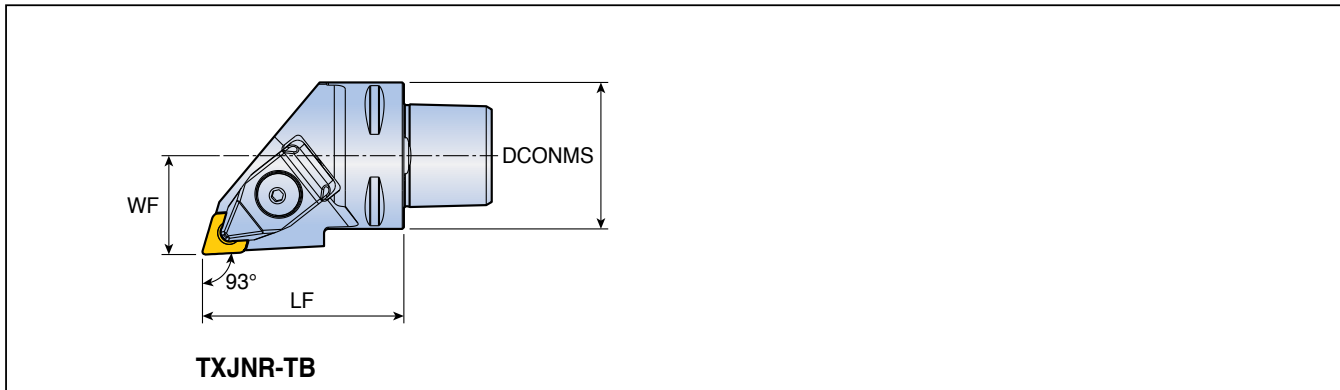

Approach angle	Designation	Dimension (mm)			Insert
		DCONMS	WF	LF	
93°	C4-TXJNR/L 27055-1105-TB	40	27	55	XN... 1105... RHINOXTURN POSSTURN
	C5-TXJNR/L 35060-1105-TB	50	35	60	

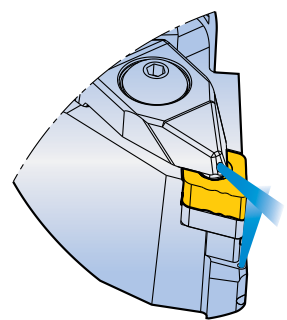
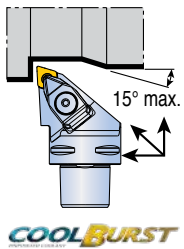

Spare parts

Designation	Clamp	Clamp Screw	Spring	Upper O-ring	Lower O-ring	Shim	Shim Screw	Wrench	
TXJNR/L-TB	DLM 3.5-NX-TB	BH M5x0.8x 21-MO-TB	DSP 4	O-RING ID5.28x 1.78	O-RING ID7.59x 2.62	TSX 3.53	SO 50090I	L-W 3	T 20